



StationMaster

Decelerator



This manual contains detailed hookup and programming instructions for the StationMaster train decelerator.

Please download “wire-to-wire” hookup diagrams at <http://www.RR-Concepts.com>.

Before we Start- Please do not attach XFMR wires (from your power pack) to any other terminals except the designated transformer inputs. (XFMR) Your StationMaster will be damaged if power is put on any of the sensor terminals!!

Remember that your StationMaster contains a micro controller and can be reset by cycling the power. To do this, turn your transformer off for a few seconds, and then turn it back on.

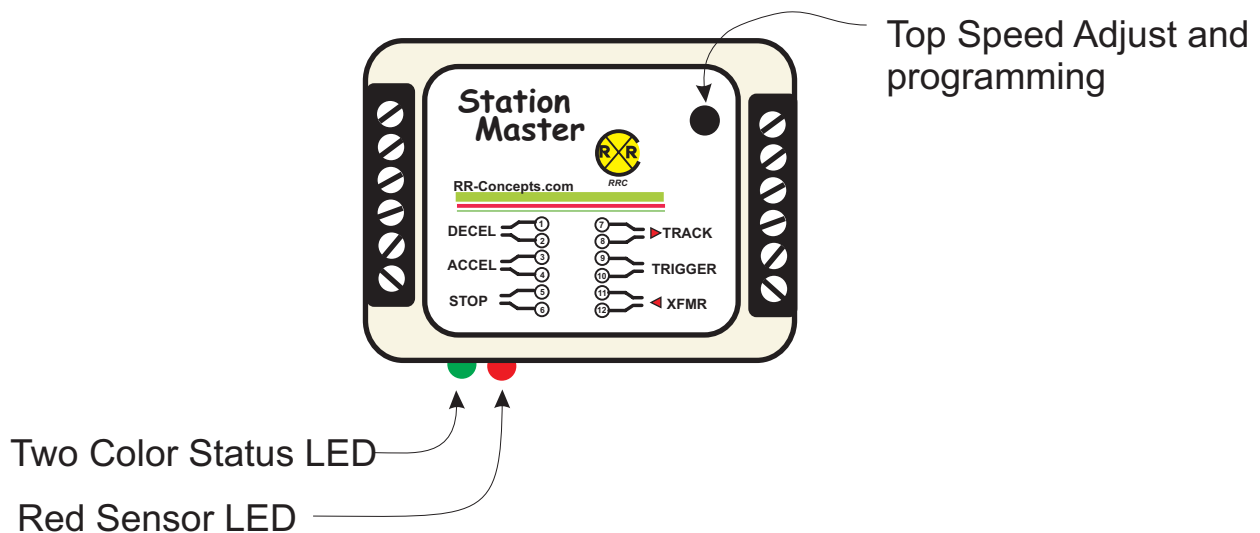

StationMaster Basic Hookup Description

The StationMaster is designed to be installed between the train transformer, and the track.

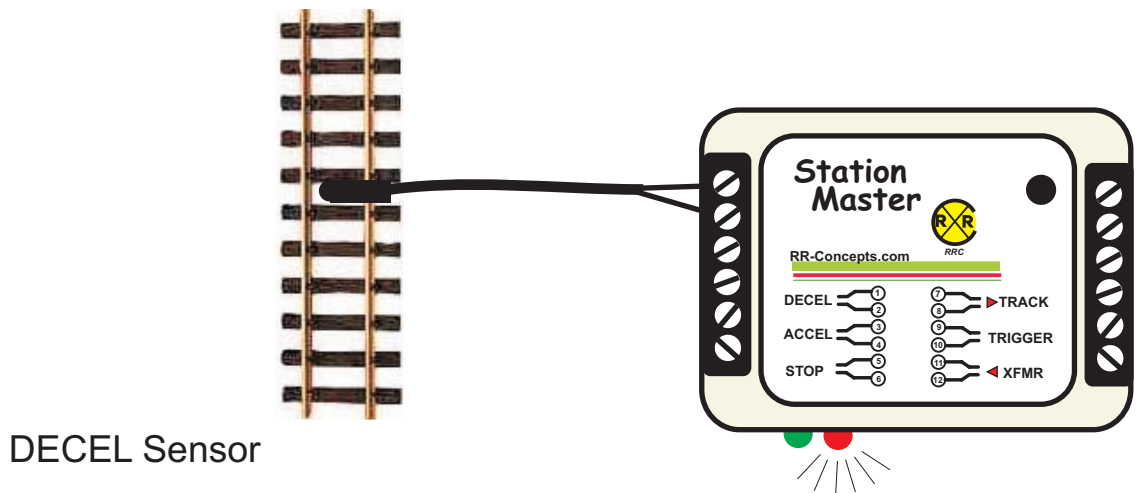
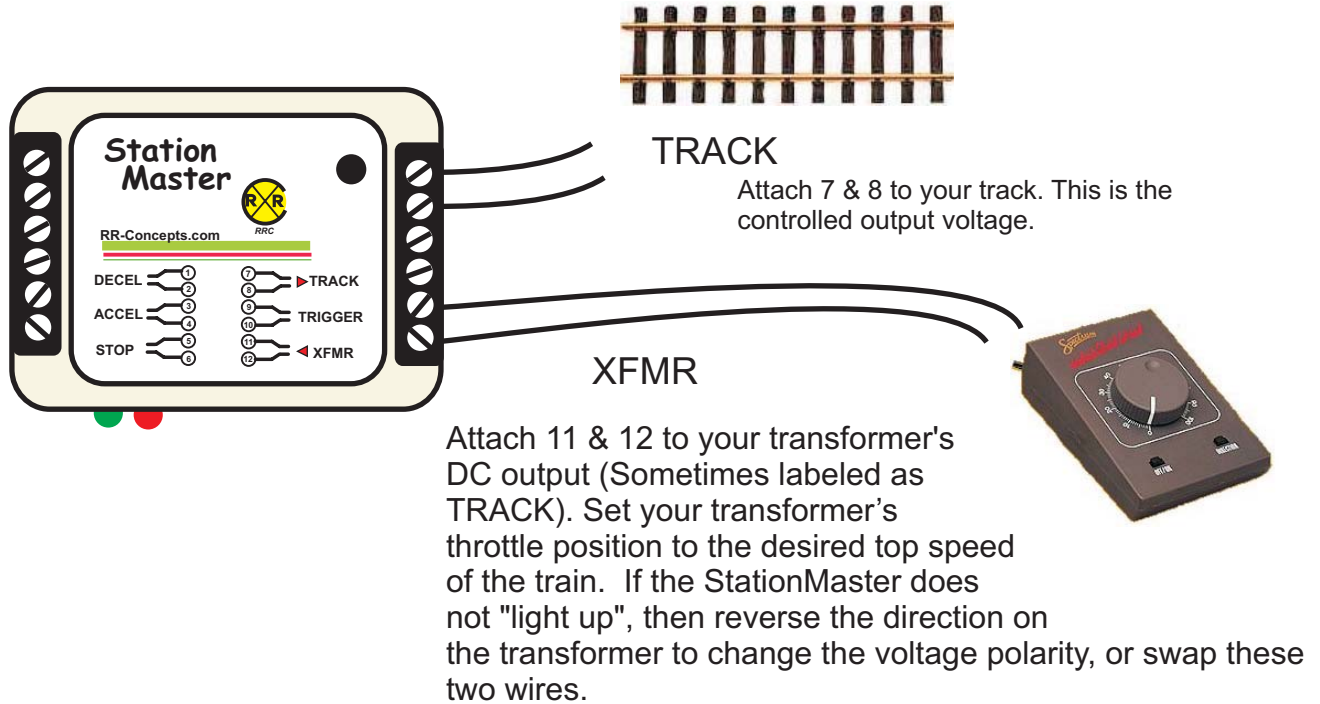

When this sensor detects a magnet, the StationMaster will decelerate your train, pause, and then accelerate. The RED led will light up when this sensor is detected. By placing multiple DECEL sensors wired in parallel, you can stop at multiple stations on your railroad.

Basic Hookup Diagram for Automatic Station Stops with Deceleration/Acceleration

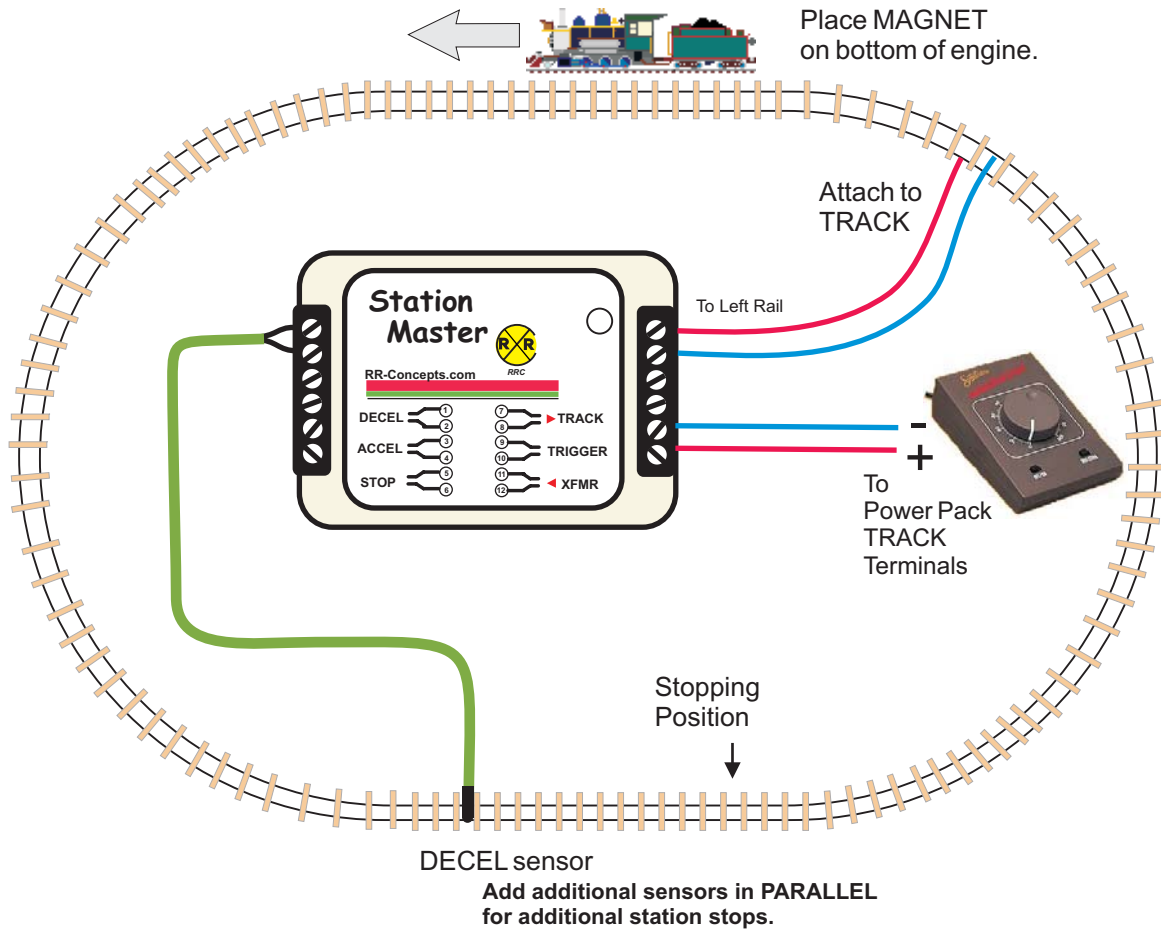

For a simple station stop, this is all you need to do!

See below for programming the deceleration, pause, and acceleration times.

Optional Sensors

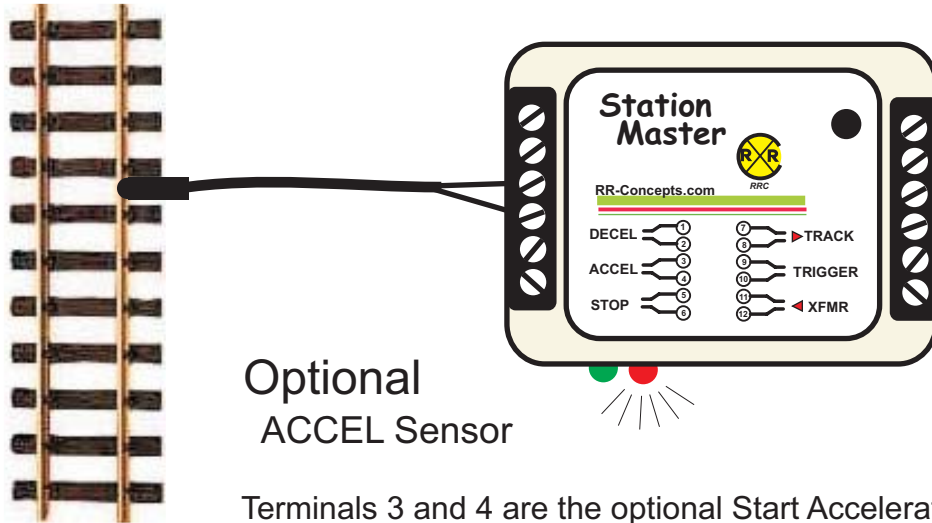

Optional ACCEL Sensor

Terminals 3 and 4 are the optional Start Acceleration sensor.

When this sensor detects a magnet, your StationMaster will accelerate the train. This sensor is **not** necessary unless using “Block Control”, advanced hookups, or the **time delay** is set for maximum. (See below)

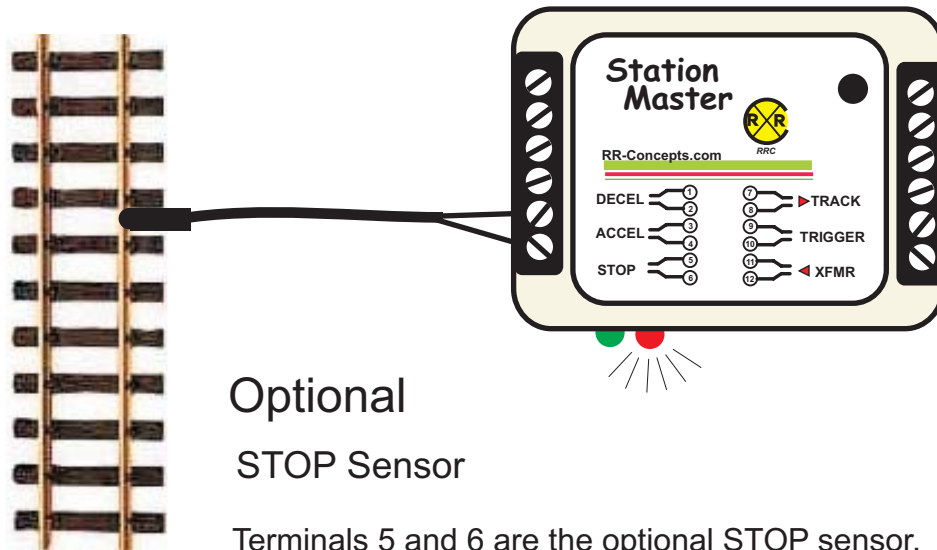

Optional STOP Sensor

Terminals 5 and 6 are the optional STOP sensor.

When the train is decelerating and this sensor detects a magnet, the train will immediately STOP. This sensor is not necessary unless using the “Self Adjusting Deceleration”, or “Two speed” operations. (See below for details on two speed operations).

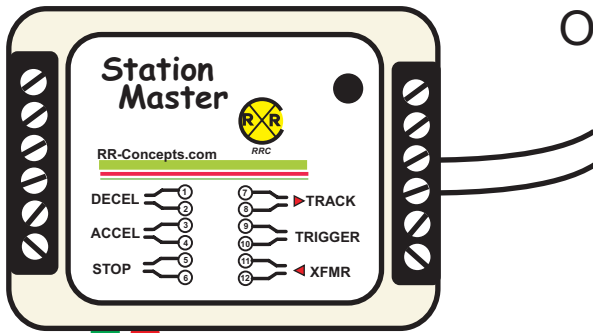

Optional

TRIGGER Output Signal

Pins 9 and 10 are TRIGGER.

These pins are an optically isolated **OUTPUT** used to trigger the SwitchMaster or another StationMaster.

These terminals should only be attached to a SwitchMaster or to another StationMaster's sensor terminals. Note that the polarity of these wires is important. If the trigger does not occur, then reverse these two wires.

These terminals are used for advanced hookups, and are not necessary for simple installations. Note that putting track power on these terminals will permanently damage the trigger circuitry. See "Trigger Programming" if the TRIGGER signal is used.

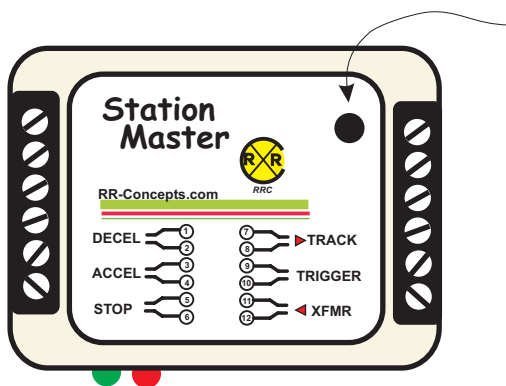

Top Speed Adjust

The top "cruising" speed of the train can be adjusted by turning the "top speed" dial.

Fully clockwise is "full speed". Turn this dial down as necessary to obtain the desired speed.

Typically, this dial is set fully clockwise and the transformer is used to set the speed of the train.

If you have a fixed DC power supply, then use this dial to set the top speed of your trains.

To program your StationMaster, turn this dial fully counter-clockwise to enter "programming mode". (See below)

Programming: Deceleration Rate

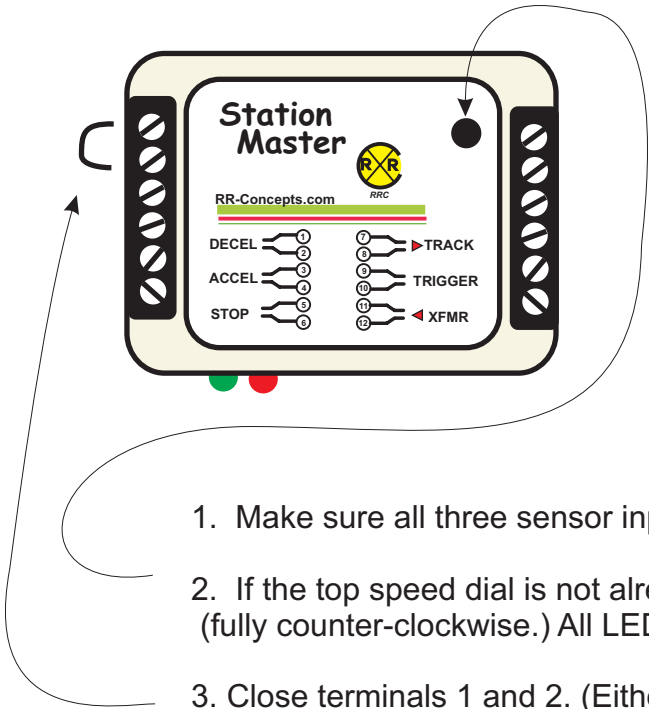

1. Make sure all three sensor inputs are open. (Red "Sensor" LED is off)
2. If the top speed dial is not already at zero, then turn the top speed dial to zero. (fully counter-clockwise.) All LED'S will turn off.
3. Close terminals 1 and 2. (Either place a magnet over the **DECEL** sensor, or touch terminals 1 and 2 together with a piece of wire or a paperclip) Keep these terminals closed.
4. Watch the TWO COLOR led. Each **RED** flash will increase the deceleration distance. **The shortest deceleration Distance will be with one flash. (TRAIN Stops fastest)** Open the terminals when the desired number of flashes have occurred. A typical number is 5. Repeat this procedure if you want a different value. The LED will turn orange when the longest Deceleration rate is set (10 counts).

When orange, the "SELF adjusting deceleration" mode will be set. (See below)

When finished with all programming, increase the top speed dial clockwise to MAX, or to a desired top speed. All programming values are stored in flash memory. This means that once you program your StationMaster, it will never forget!

Programming: Acceleration Rate

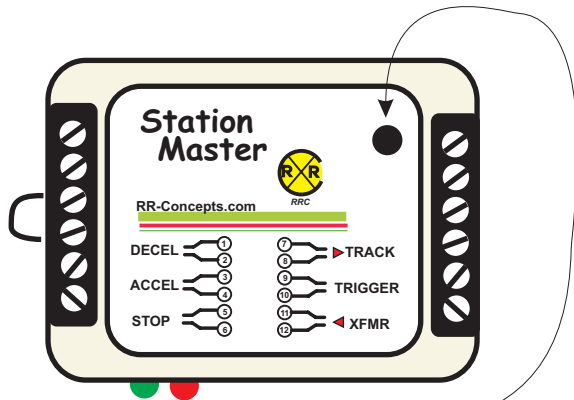

1. Make sure all three sensor inputs are open. (Red "Sensor" LED is off)
2. If the top speed dial is not already at zero, then turn the top speed dial to zero. (fully counter-clockwise.) All LED'S will turn off.
3. Close terminals 3 and 4. (Either place a magnet over the **ACCEL** sensor, or touch terminals 3 and 4 together with a piece of wire or a paperclip)
Keep these terminals closed.
4. Watch the TWO COLOR led. Each GREEN flash will decrease the acceleration rate. **The fastest acceleration will be with one flash.**
Open the terminals when the desired number of flashes have occurred. A typical number is 5. Repeat this procedure if you want a different value.
The LED will turn orange when the longest **acceleration** rate is set (about 10 counts).

When finished with all programming, increase the top speed dial clockwise to MAX, or to a desired top speed. All programming values are stored in flash memory. This means that once you program your StationMaster, it will never forget!

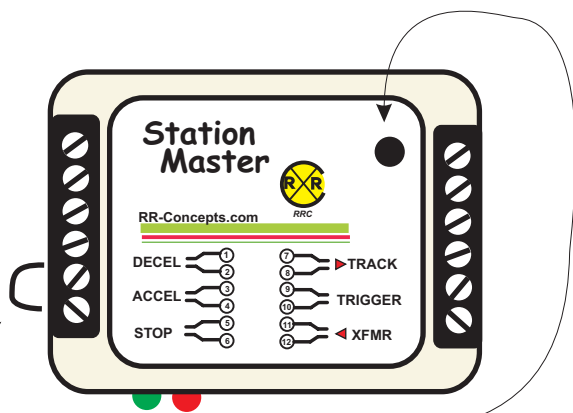

Programming: Pause Time

1. Make sure all three sensor inputs are open. (red "Sensor" Led is off)
2. If the top speed dial is not already at zero, then turn the top speed dial to zero. (fully counter-clockwise.) All LED'S will turn off.
3. Close terminals 5 and 6. (Either place a magnet over the **STOP** sensor, or touch terminals 5 and 6 together with a piece of wire or a paperclip) Keep these terminals closed.
4. Watch the TWO COLOR led. Each ORANGE flash will increase the waiting time. **A wait time of zero will be with one flash.** Open the terminals when the desired number of flashes have occurred. A typical number is 5. Repeat this procedure if you want a different value.

The LED will turn orange when an infinite delay is set (after 10 counts). **When infinite delay is set, then the ACCEL sensor is required to start up the train after a station stop.** A fun thing to do would be to connect the ACCEL terminals to a doorbell switch. Your train would patiently wait until someone pushed the button!

When finished with all programming, increase the top speed dial clockwise to MAX, or to a desired top speed. All programming values are stored in flash memory. This means that once you program your StationMaster, it will never forget!

The number of orange FLASHES will correspond to the following time delays:

- 1: 0 seconds, no wait.
- 2: 10 seconds,
- 3: 20 seconds,
- 4: 30 seconds,
- 5: 1 minute,
- 6: 2 minutes,
- 7: 5 minutes,
- 8: 10 minutes,
- 9: 30 minutes,
- 10: Infinite, wait for GO sensor.

Note that these times are not exact. Actual time values will be within 2%.

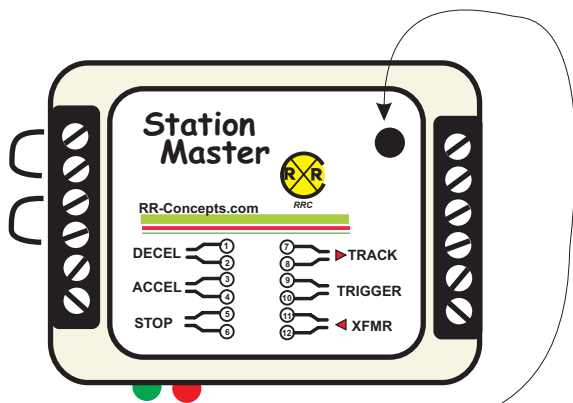

OPTIONAL: Programming the TRIGGER behaviour

The TRIGGER is an output voltage that can be used to send a signal to an external device. The StationMaster can be programmed to send a TRIGGER signal either before the station pause, or after the pause.

To change the trigger behavior, perform these steps:

1. Make sure the top speed dial is at top speed. (Fully clockwise)
2. Close BOTH the DECEL and ACCEL terminals.
3. Turn the top speed dial counter-clockwise until the red LED flashes.
 If the red LED flashes twice, then the trigger will occur when the train stops.
 If the red LED flashes once, then the trigger will occur when the train accelerates.
4. Repeat this procedure to toggle the trigger behavior. (Turn top speed dial clockwise, and then counter-clockwise.)

When finished, turn the top speed dial clockwise as desired, and open all terminals. (Remove magnets on sensors, or remove shorting wires.)

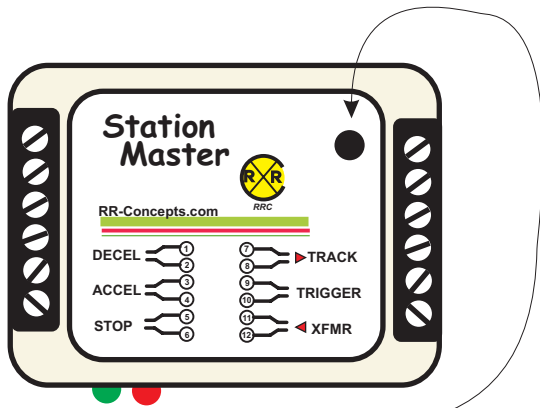

OPTIONAL: Programming the StationMaster for TWO LAPS

The StationMaster can be programmed to allow your trains to make two laps before stopping.

To change the two lap behavior, preform these steps:

1. Make sure the top speed dial is at zero. (Fully counter-clockwise)
2. Make sure all sensor terminals are open.
3. Slowly turn the top speed dial clockwise until a LED flashes, and then immediately turn the dial back down to zero.
If the red LED flashes twice, then your trains will run two laps before stopping.
If the red LED flashes once, then your trains will run one lap before stopping.
4. Repeat this procedure to toggle the trigger behavior. (Turn top speed dial clockwise until a LED come on, and then counter-clockwise again.

When finished, turn top speed dial clockwise to the top speed position.

Notice that the two color LED will blink green when accelerating with one lap, and will blink red/green when accelerating with two laps.

Self Adjusting Deceleration Mode

A unique feature of the StationMaster is “Self Adjusting Deceleration”. By using both a DECEL sensor and a STOP sensor, the StationMaster will self-program itself for the most optimum and realistic deceleration profile. Programming your StationMaster to use “Self Adjusting Deceleration” is very easy:

1. Program your **deceleration** to **MAXIMUM**. (About 10 flashes)
2. Place the **DECEL** and **STOP** sensors on your track as shown. The distance between sensors should be between 2 and 10 feet.

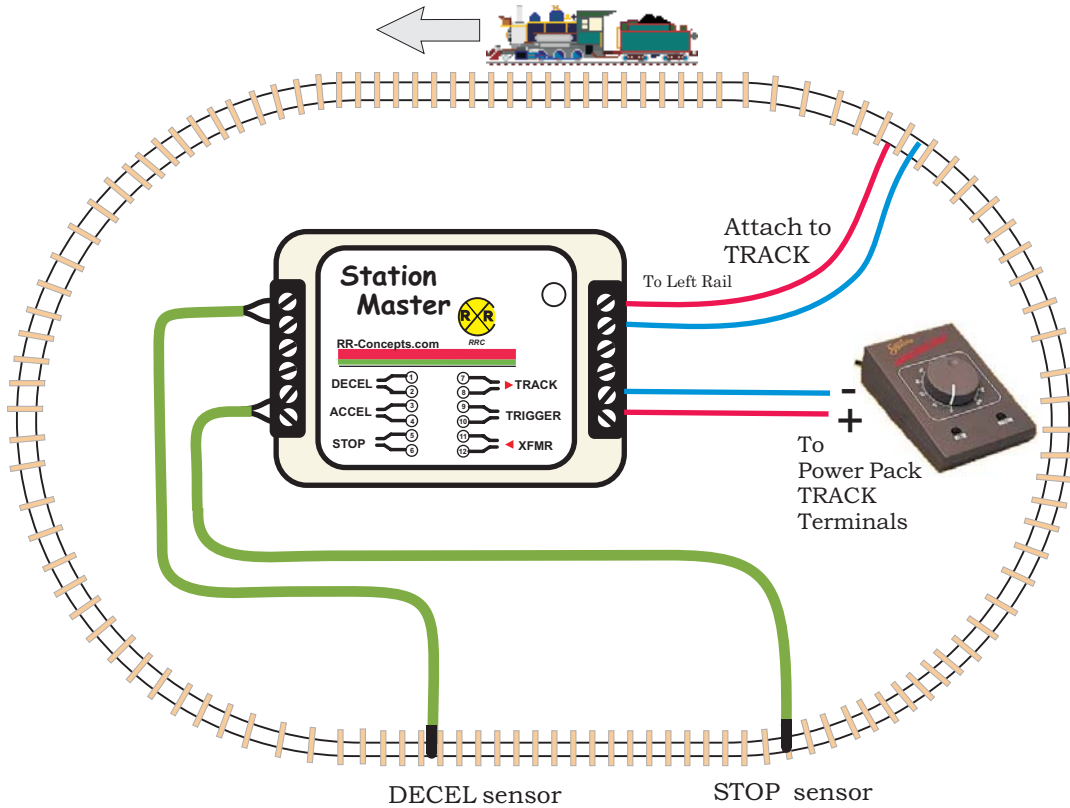

When “Self Adjusting Deceleration” is turned on for the first time, the train will operate as follows:

1. After traveling over the DECEL sensor, the train will travel until the STOP sensor is detected, and then abruptly stop.
2. The deceleration time will be automatically adjusted each lap, such that the train will “ease” into the stopping location after about 5 laps. This time will be saved in memory.
3. If the speed of the train is so slow that it does not move while “hunting” for the STOP sensor, then the “hunting” speed will be increased after 25 seconds. **Please wait at least 30 seconds for the StationMaster to self-adjust if your train ever stops before reaching the STOP sensor.**
4. Trains will not “park” on the STOP sensor. If your train stops on top of a STOP sensor, then it will slowly move forward until the sensor is clear. Please be patient if your train seems to be stopped. It’s being automatically controlled like a real train!
5. One last thing to note: The Self-Adjusting Deceleration can be used with one train, or two totally different trains!! If two trains are controlled, then they will EACH have their own unique deceleration profile. The StationMaster actually maintains two deceleration profiles, alternating between them every time a deceleration starts. This is perfect when you have a slow train followed by a fast train!

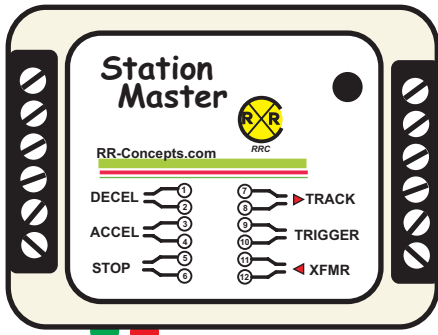

LED indicators

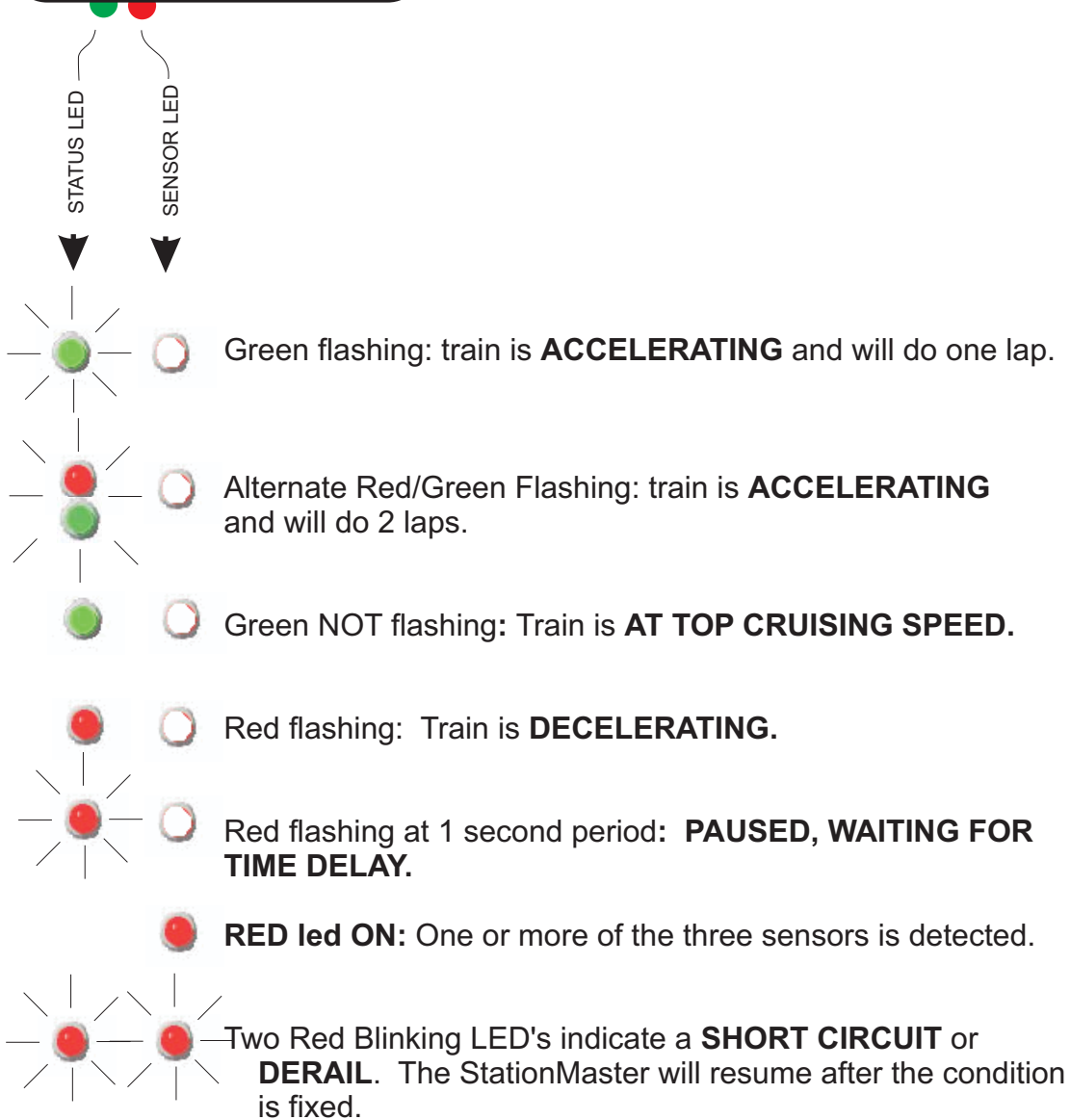

WARRANTY

Your StationMaster is warranted, and guaranteed operational for 1 year. It will be repaired or replaced at no charge within that time period. Contact <http://www.RR-Concepts.com> for additional information.

Some Advanced Hookup Examples

Block Control

For Multiple Trains on 1 Track using a **StationMaster**

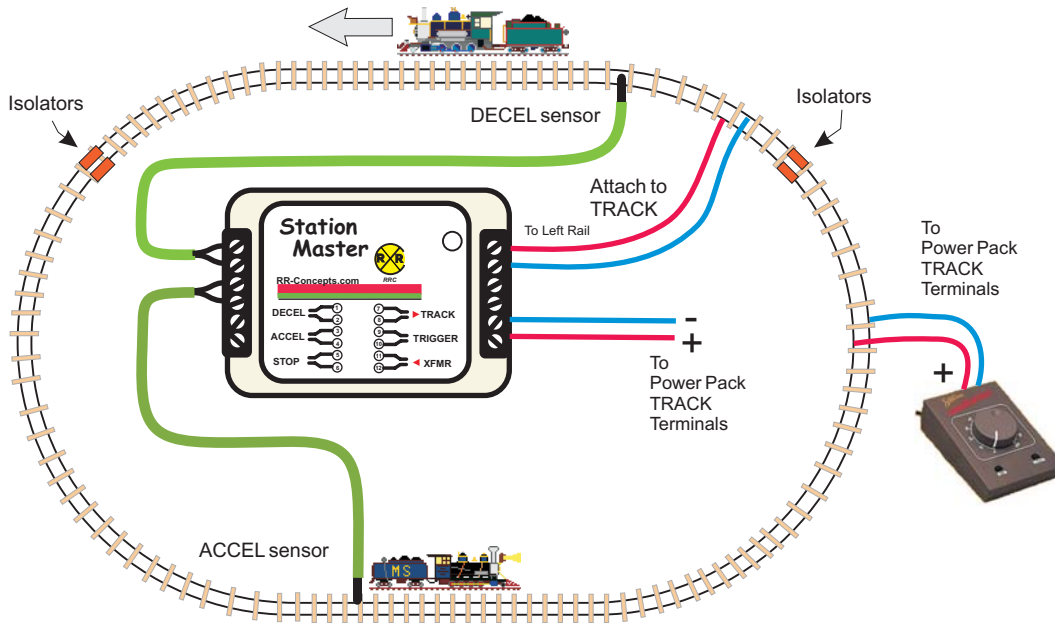

Hookup Notes:

1. Your train may not stop if the second train is too close.
2. If the train stops, it must do so before reaching the isolators.
3. If the train is slowing or stopped, then the second train till tell it to "go" when it hits the ACCEL sensor.
4. The TIME DELAY must be programmed for MAXIMUM.

Speed Control

Your train can accelerate and decelerate to two different speeds if desired.

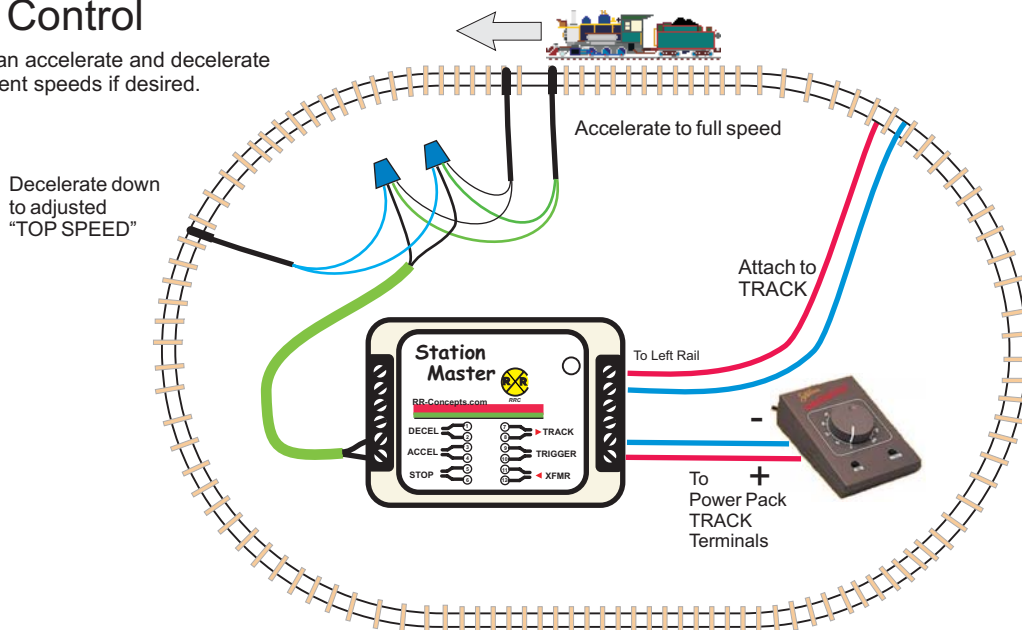

Hookup Notes:

1. Turn your "top speed" dial down to a slower speed.
2. Speed control is only active when the StationMaster is not accelerating or decelerating. (GREEN LED is on)
3. All sensors are wired in parallel as shown, and attached to the STOP sensor.
4. When a train passes over 2 STOP sensors within 2 seconds, it will accelerate up to full speed as set by your transformer.
5. When a train passes over 1 STOP sensor within 2 seconds, it will decelerate down to the speed set by the "top speed" dial.
6. Yes, you can still use the DECEL sensor and/or STOP sensors to perform regular station stops.
7. Yes, you can add additional sensors in parallel to speed up and slow down at multiple locations.
8. A normal StationMaster acceleration sequence will accelerate your train up to the dialed in top speed. Changing speed by using these sensors is a temporary condition that is reset by the next DECEL/ACCEL or cycling power to the StationMaster.
9. Use this to slow down over precarious trestles or curves, and accelerate up grades. It can add a lot of wires, but your railroad will become truly automated!

Multiple Station Stops

Your train can stop at many stations on the loop by adding DECEL sensors in parallel.

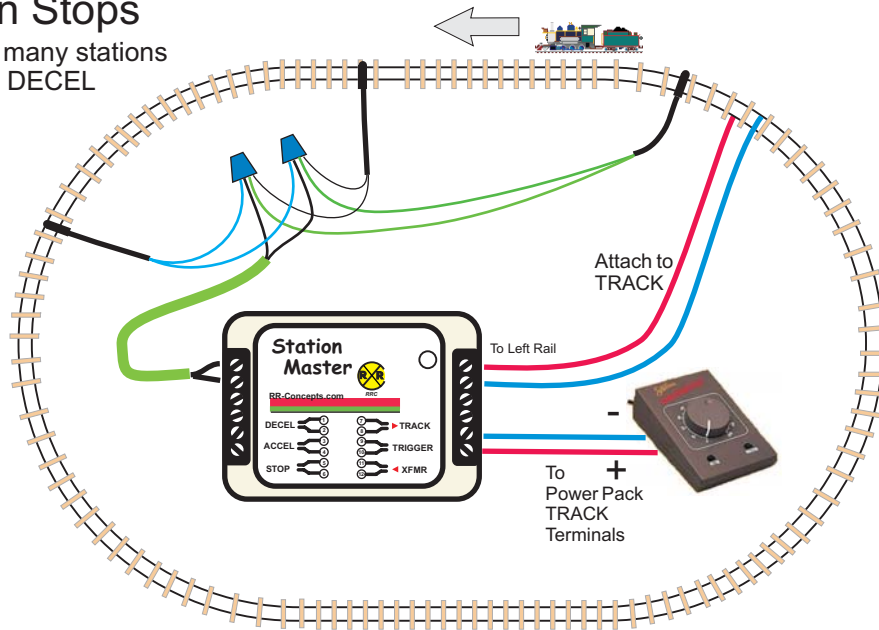

Every sensor that the train passes over will cause a decelerate/pause/accelerate sequence.

Sensor Placement on Track

Suggested Sensor Placement on track with the magnet installed in the center of the train.

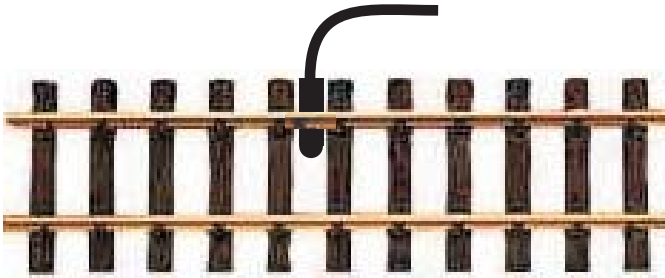

Sensor Placement for identifying a train. Offset the train's magnet to the same side.

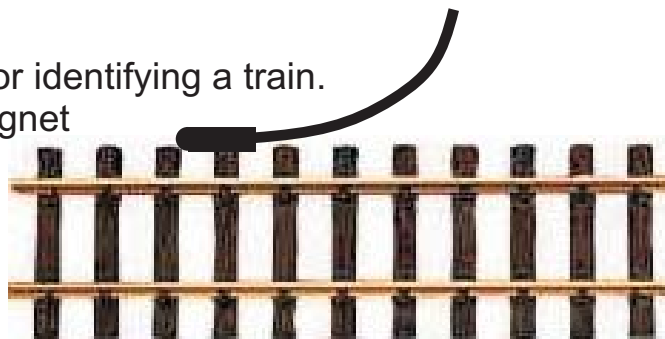

For example, passenger trains have the magnet on the right and stop at the passenger station. Freight trains have their magnet on the left and stop at the freight station.

Enjoy your StationMaster!